

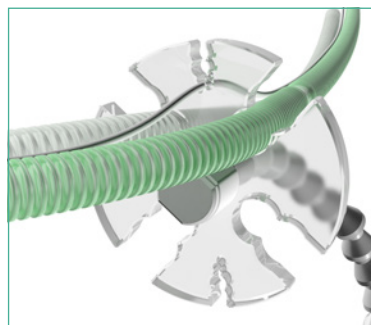

Tube management programme

Help to provide a safe and tidy environment reducing the risk of disconnection and patient trauma.

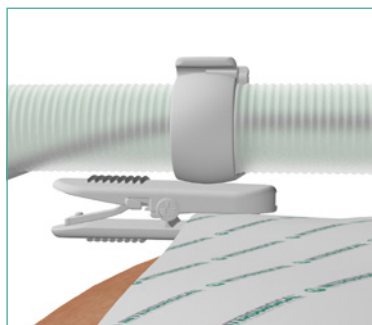

Critical Care ▪ Accessories

Tube management programme

When used in conjunction with Intersurgical breathing systems our full range of tube management options allow the clinician to position our products efficiently and comfortably around the patient area. These help to provide a safe and tidy environment reducing the risk of disconnection and patient trauma.

Intersurgical tube clips, 22F red dust cap, humidification chamber fill set spike cover, and tube clip hanger are designed to interface with the tube management clip or grip via a notch feature.

Tube clips are available to fit our Smoothbore and Flextube™ breathing systems with options available for 10 mm, 15 mm, 22 mm and 30 mm single and dual limb breathing systems.

[Make an enquiry](#)

[Watch the video](#)

Tube support

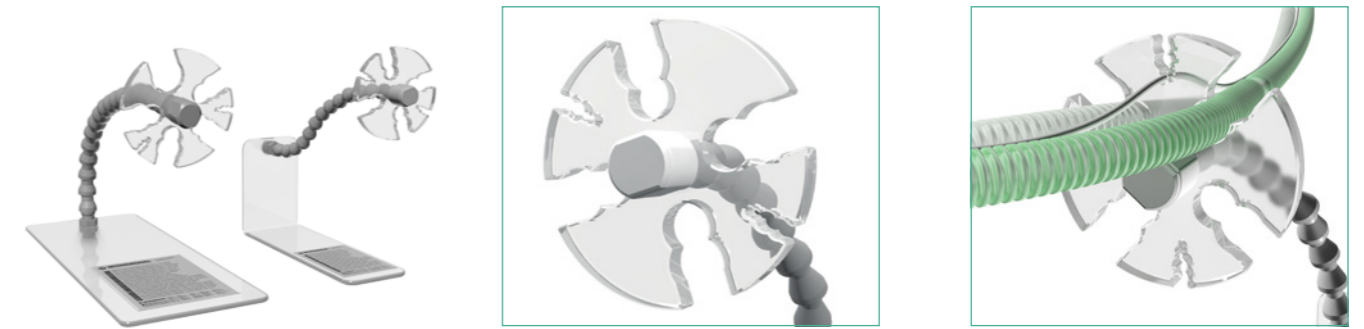

Our ergonomically designed tube support is a neat way of securely holding a breathing system close to the patient. Available in two sizes the tube support efficiently holds in place 10, 15, 22 and 30 mm tubes with a smaller groove to grip monitoring lines and cables. The flexible neck is easily positioned to take the strain of the breathing system away from the patient.

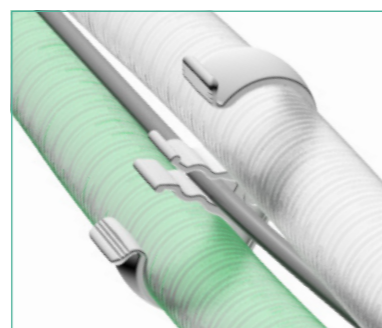
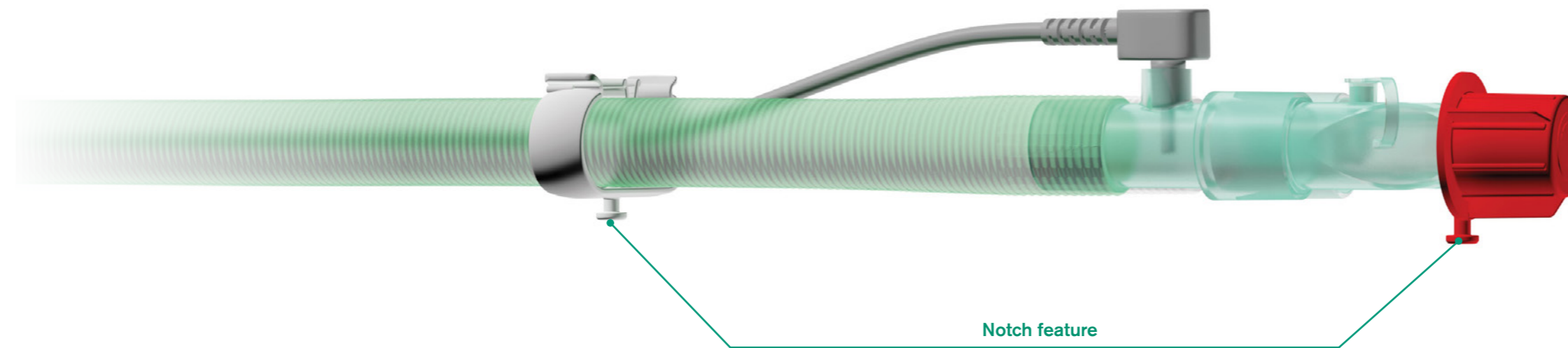

Tube clips 10 mm,
15 mm, 22 mm, 30 mm

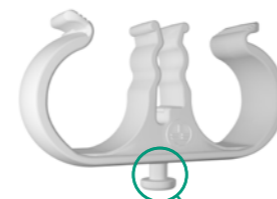

Red dust cap or
humidification chamber
fill set spike cover



Notch feature interfaces with

Tube management grip



Tube management clip

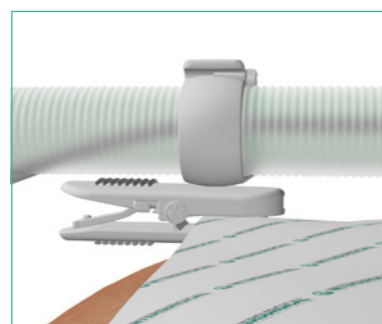

Tube management guide

Flextube™ and Smoothbore tube clip



Code	2317000
Box Qty.	25

Flextube tube clip

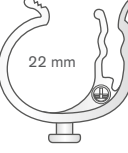

Code	2315000
Box Qty.	25

Smoothbore tube clip

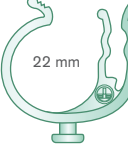

Code	2318000
Box Qty.	25

Flextube tube clip

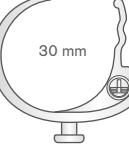

Code	2319000
Box Qty.	25

Flextube and Smoothbore tube clip

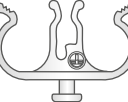

Code	2311000
Box Qty.	25

Flextube and Smoothbore tube clip

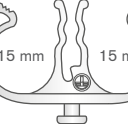

Code	2312000
Box Qty.	25

Flextube tube clip

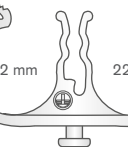

Code	2313000
Box Qty.	25

Smoothbore tube clip

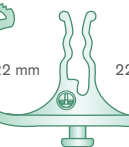

Code	2314000
Box Qty.	25

Tube management clips with tube clips



Code	2316000
Box Qty.	12

Tube support
30 mm/
22 mm/
15 mm



Code	5904000
Box Qty.	1

Tube support
15 mm/10 mm



Code	5905000
Box Qty.	1

Tube management grip



Code	2321000
Box Qty.	50

Tube clip hanger

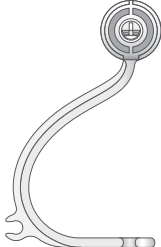

Code	5572000
Box Qty.	25

IS1.40 • Issue 4 11.24



Intersurgical Ltd, Crane House, Molly Millars Lane, Wokingham, Berkshire, RG41 2RZ, UK
T: +44 (0)118 965 6300 info@intersurgical.com www.intersurgical.com



The manufacturer Intersurgical Ltd is certified to ISO 14001:2015, ISO 9001:2015, ISO 13485:2016 and MDSAP

Please think before you print
Save energy and paper.
If you must print this information sheet please print it double sided.